



# Torpedo-like AUV control in constrained environment

---

Quentin Bateau

December 1, 2022

ENSTA Bretagne

# Context

---

## Research laboratory

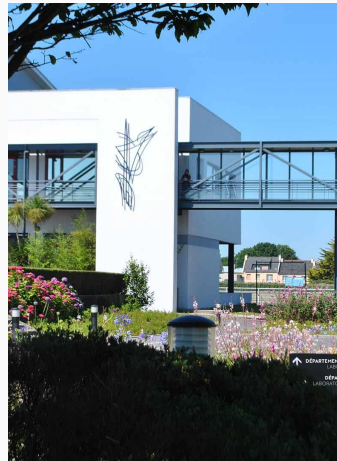
- ENSTA Bretagne, UMR 6285, Lab-STICC

## Supervisors

- Luc Jaulin
- Fabrice Lebars

## Funding

- AID funding: Jean-Daniel Masson



## AUV

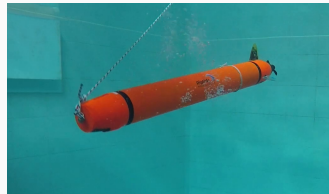
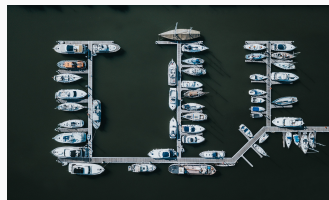
- Control of torpedo-like AUV
- Riptide's micro-uuv

## Environment

- Constrained environment
- Pool, harbor, ...

## Goals

- Reactivity
- Manoeuvrability



**Figure 1:** Harbor and Riptide in the ENSTA Bretagne pool

# Motivation

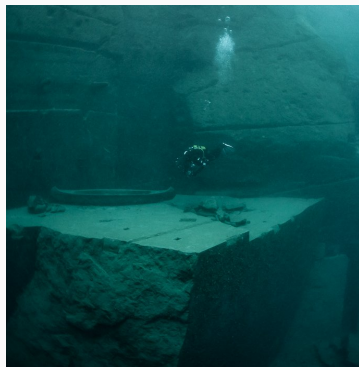
---

## Wall avoidance

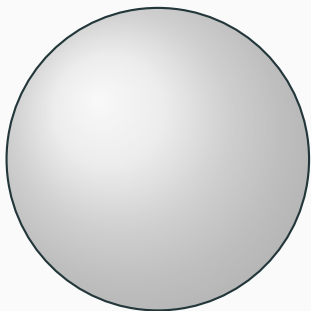
- Sense wall
- Determine normal vector  $\mathbf{u}$
- Reorient AUV orthogonal to  $\mathbf{u}$

## Control law

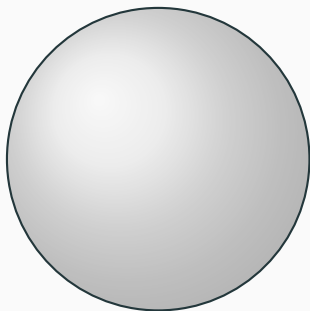
- Without singularities
- Based on reliable sensors
- Independent of orientation
- As fast as possible



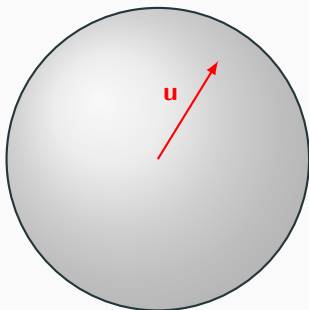
**Figure 2:** Vodelée quarry - Belgium



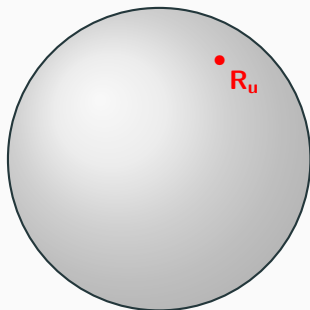
**Figure 3:** Representation in  $S^2$



**Figure 4:** Representation in  $SO(3)$

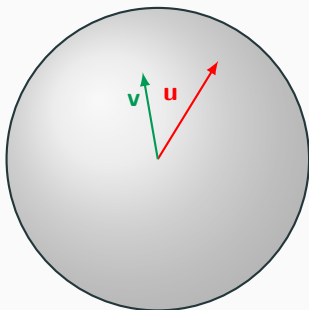


**Figure 3:** Representation in  $S^2$

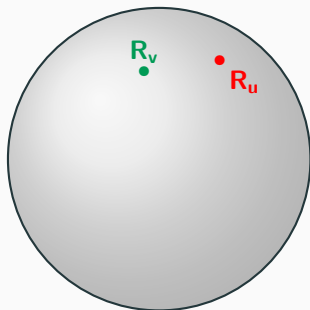


**Figure 4:** Representation in  $SO(3)$





**Figure 3:** Representation in  $S^2$



**Figure 4:** Representation in  $SO(3)$

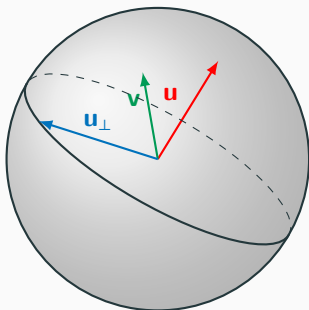


Figure 3: Representation in  $S^2$

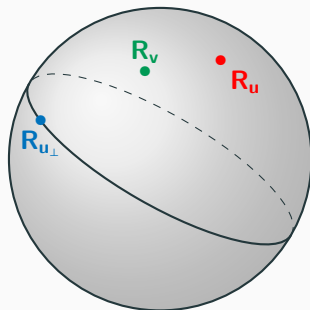


Figure 4: Representation in  $SO(3)$

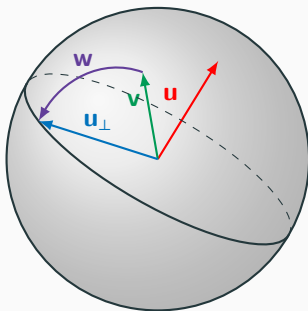


Figure 3: Representation in  $S^2$

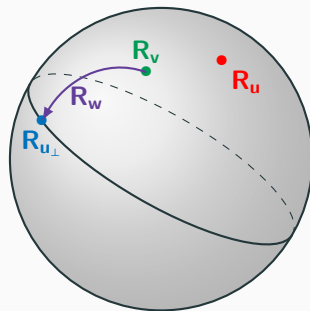
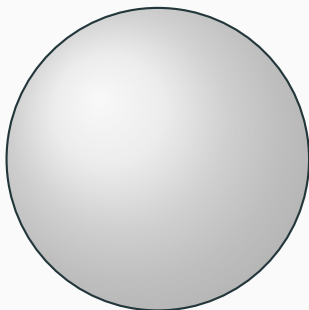
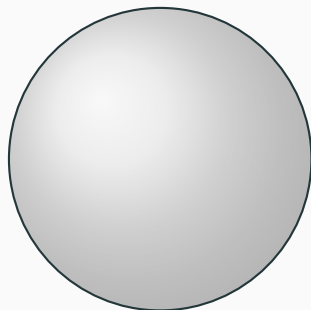


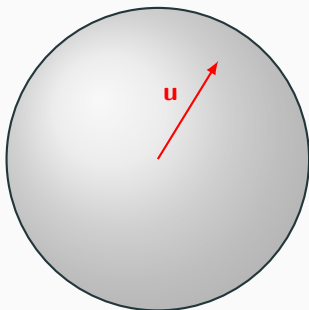
Figure 4: Representation in  $SO(3)$



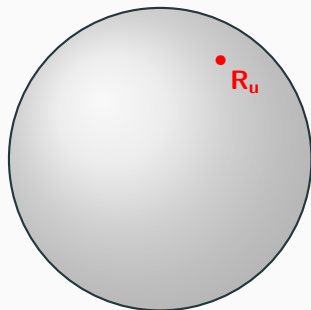
**Figure 5:** Representation in  $S^2$



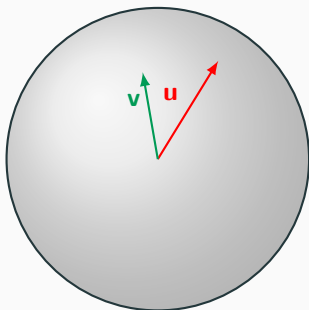
**Figure 6:** Representation in  $SO(3)$



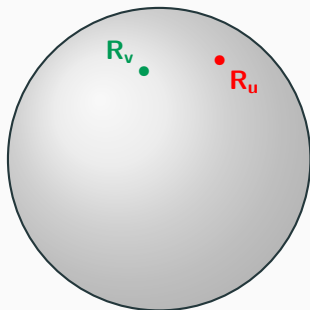
**Figure 5:** Representation in  $S^2$



**Figure 6:** Representation in  $SO(3)$



**Figure 5:** Representation in  $S^2$



**Figure 6:** Representation in  $SO(3)$

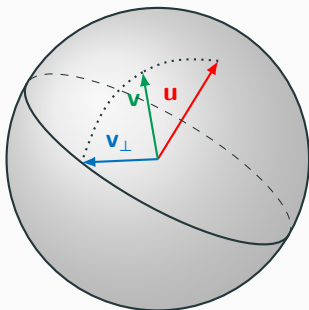


Figure 5: Representation in  $S^2$

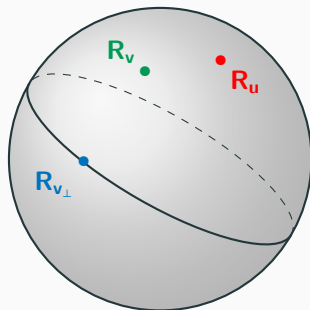


Figure 6: Representation in  $SO(3)$

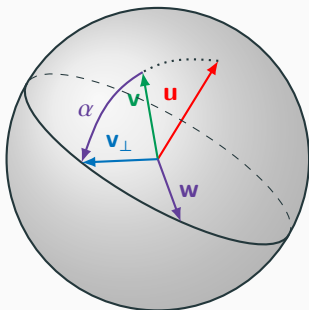


Figure 5: Representation in  $S^2$

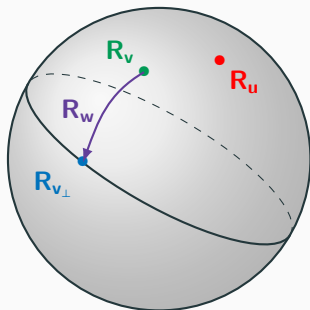


Figure 6: Representation in  $SO(3)$



## Classical control<sup>1</sup>

### Strengths

- Already implemented
- Fully controlled orientation

### Weaknesses

- Complete knowledge of  $\mathbf{R}$
- Set all angles
- Slower reorientation

## Orthogonal control

### Strengths

- Partial knowledge of  $\mathbf{R}$
- Set only necessary angles
- Quickest reorientation
- Other angles controllable

### Weaknesses

- Uncontrolled direction

---

<sup>1</sup>Jaulin (2019)

# Orthogonal control

---

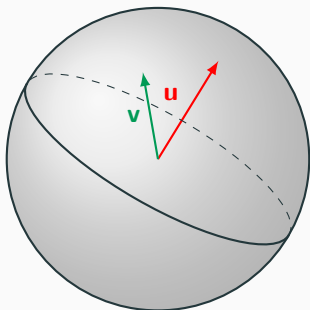


Figure 7: Representation in  $S^2$

Determine  $v_{\perp}$

$$v_{\perp} = \frac{\mathbf{v} - \langle \mathbf{u}, \mathbf{v} \rangle \cdot \mathbf{u}}{\|\mathbf{v} - \langle \mathbf{u}, \mathbf{v} \rangle \cdot \mathbf{u}\|} \quad (1)$$

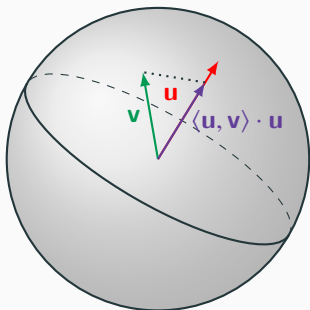
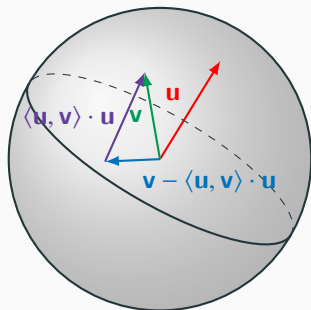


Figure 7: Representation in  $S^2$

Determine  $v_{\perp}$

$$v_{\perp} = \frac{v - \langle u, v \rangle \cdot u}{\|v - \langle u, v \rangle \cdot u\|} \quad (1)$$

Figure 7: Representation in  $S^2$ Determine  $v_{\perp}$ 

$$\mathbf{v}_{\perp} = \frac{\mathbf{v} - \langle \mathbf{u}, \mathbf{v} \rangle \cdot \mathbf{u}}{\|\mathbf{v} - \langle \mathbf{u}, \mathbf{v} \rangle \cdot \mathbf{u}\|} \quad (1)$$

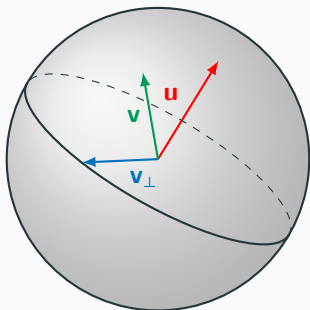


Figure 7: Representation in  $S^2$

Determine  $v_{\perp}$

$$v_{\perp} = \frac{v - \langle u, v \rangle \cdot u}{\|v - \langle u, v \rangle \cdot u\|} \quad (1)$$

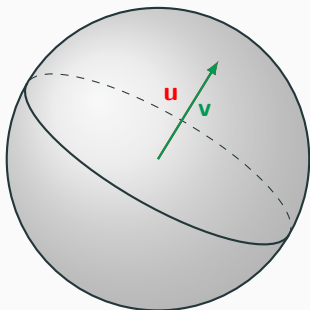


Figure 7: Representation in  $S^2$

Determine  $v_{\perp}$

$$v_{\perp} = \frac{\mathbf{v} - \langle \mathbf{u}, \mathbf{v} \rangle \cdot \mathbf{u}}{\|\mathbf{v} - \langle \mathbf{u}, \mathbf{v} \rangle \cdot \mathbf{u}\|} \quad (1)$$

**Limitation**

Physical singularity when  $\mathbf{u} = \mathbf{v}$ , as  $v_{\perp}$  is undefined

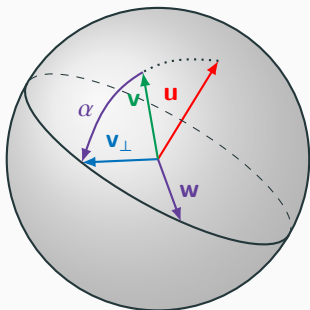


Figure 8: Representation in  $S^2$

## Determine $R_w$

$$w = v \wedge v_{\perp}$$

$$\alpha = \arccos(\|w\|) \quad (2)$$

$$R_w = \exp\left(\alpha \frac{w}{\|w\|} t\right)$$



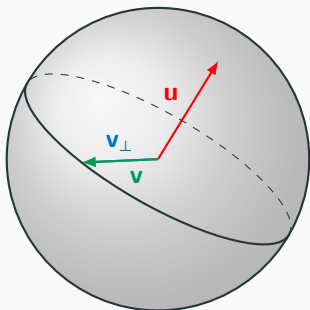


Figure 8: Representation in  $S^2$

## Determine $R_w$

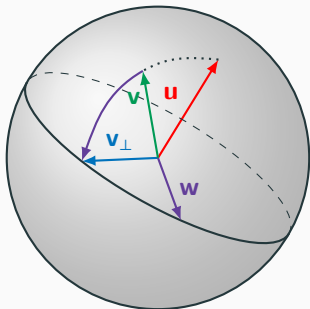
$$w = v \wedge v_{\perp}$$

$$\alpha = \arccos(\|w\|) \quad (2)$$

$$R_w = \exp\left(\alpha \frac{w}{\|w\|} t\right)$$

## Issue

- If  $v = v_{\perp}$ ,  $\|w\| = 0$



**Figure 9:** Representation in  $S^2$

## Codesido formula<sup>2</sup>

$$\begin{aligned}
 K_v^{v_{\perp}} &= v_{\perp} v^T - v v_{\perp}^T \\
 R_v^{v_{\perp}} &= I_3 + K_v^{v_{\perp}} + \frac{1}{1 + \langle v, v_{\perp} \rangle} (K_v^{v_{\perp}})^2
 \end{aligned} \tag{3}$$

<sup>2</sup>Cid and Tojo (2018)

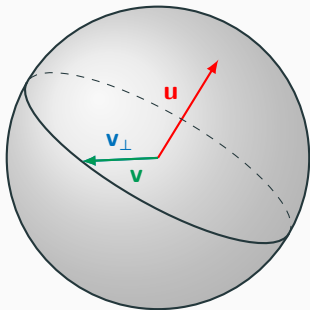


Figure 9: Representation in  $S^2$

## Codesido formula<sup>2</sup>

$$\begin{aligned} K_v^{v_\perp} &= v_\perp v^T - v v_\perp^T \\ R_v^{v_\perp} &= I_3 + K_v^{v_\perp} + \frac{1}{1 + \langle v, v_\perp \rangle} (K_v^{v_\perp})^2 \end{aligned} \quad (3)$$

## No singularities

- If  $v = v_\perp$ ,  $R_v^{v_\perp} = I_3$

<sup>2</sup>Cid and Tojo (2018)

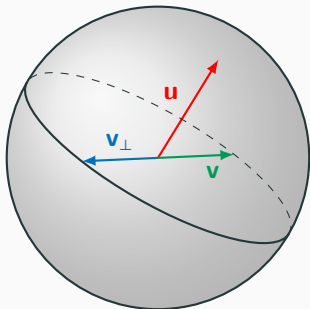


Figure 9: Representation in  $S^2$

## Codesido formula<sup>2</sup>

$$\begin{aligned} K_v^{v_\perp} &= v_\perp v^T - v v_\perp^T \\ R_v^{v_\perp} &= I_3 + K_v^{v_\perp} + \frac{1}{1 + \langle v, v_\perp \rangle} (K_v^{v_\perp})^2 \end{aligned} \quad (3)$$

## No singularities

- If  $v = v_\perp$ ,  $R_v^{v_\perp} = I_3$
- Singularity when  $\langle v, v_\perp \rangle = -1$

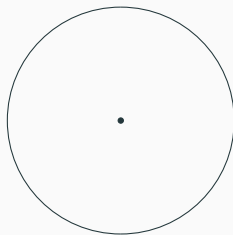
<sup>2</sup>Cid and Tojo (2018)

## 2D Examples

---



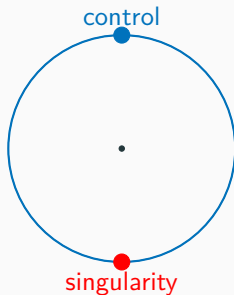
**Figure 10:** Wall avoidance -  
Classical control



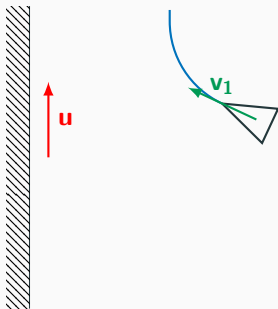
**Figure 11:** Representation in  $S^1$



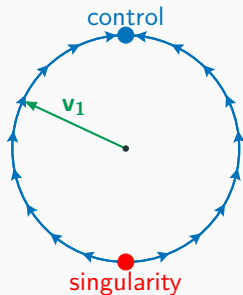
**Figure 10:** Wall avoidance -  
Classical control



**Figure 11:** Representation in  $S^1$

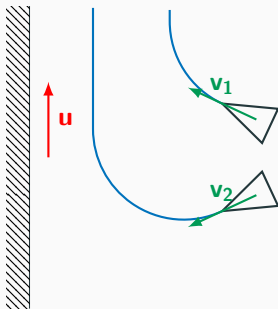


**Figure 10:** Wall avoidance -  
Classical control

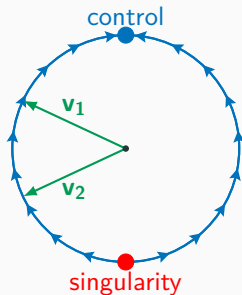


**Figure 11:** Representation in  $S^1$





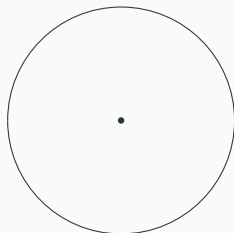
**Figure 10:** Wall avoidance -  
Classical control



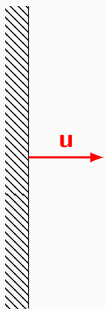
**Figure 11:** Representation in  $S^1$



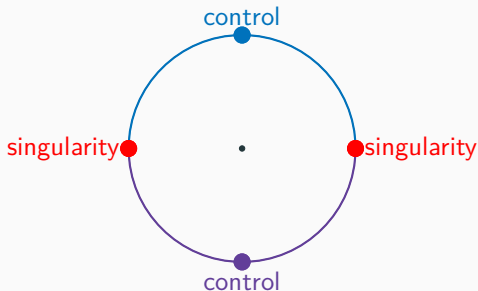
**Figure 12:** Wall avoidance -  
Proposed approach



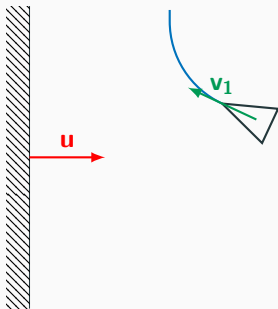
**Figure 13:** Representation in  $S^1$



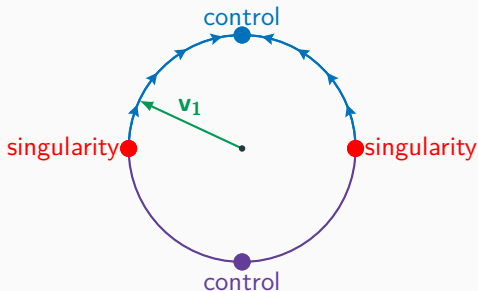
**Figure 12:** Wall avoidance -  
Proposed approach



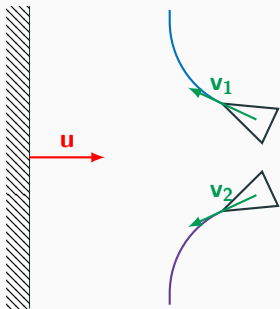
**Figure 13:** Representation in  $S^1$



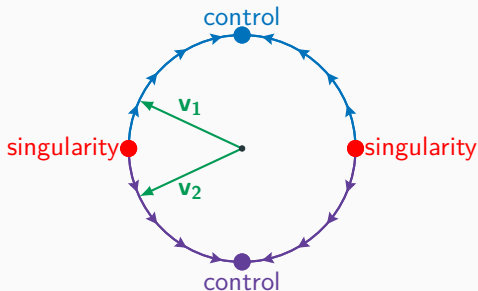
**Figure 12:** Wall avoidance -  
Proposed approach



**Figure 13:** Representation in  $S^1$



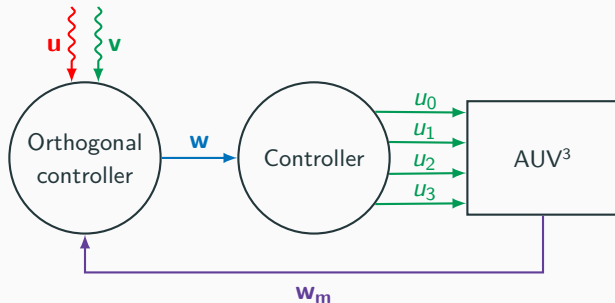
**Figure 12:** Wall avoidance -  
Proposed approach



**Figure 13:** Representation in  $S^1$

## AUV application

---



**Figure 14:** Block diagram - Orthogonal controller

---

<sup>3</sup>Fossen (2011)

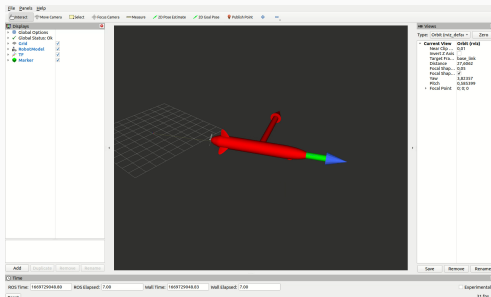
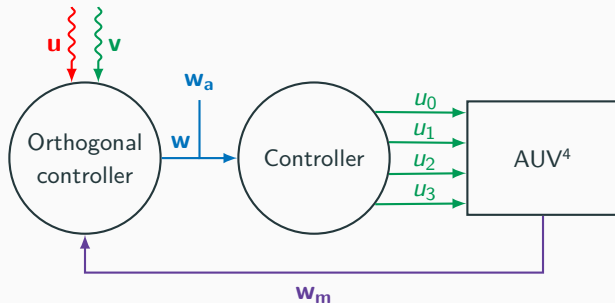


Figure 15: 1 orthogonal constraint

## Simulation

- 1 constraint  $\mathbf{v} \perp \mathbf{u}$
- $\mathbf{u} = \text{AxisRot}\left(\frac{\pi}{8}, \mathbf{z}\right)$
- $\mathbf{v} = (1, 0, 0)^T$





**Figure 16:** Block diagram - Orthogonal controller

---

<sup>4</sup>Fossen (2011)

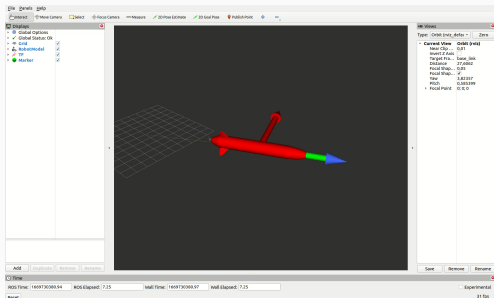


Figure 17: Random orthogonal constraint with  $w_a$  injection

## Simulation

- 1 constraint  $\mathbf{v} \perp \mathbf{u}$
- $\mathbf{u} = \text{random}$
- $\mathbf{v} = (1, 0, 0)^T$

## $w_a$ injection

- $\mathbf{w}_a = (w_x, 0, 0)$
- $w_x$  changing every 2 seconds

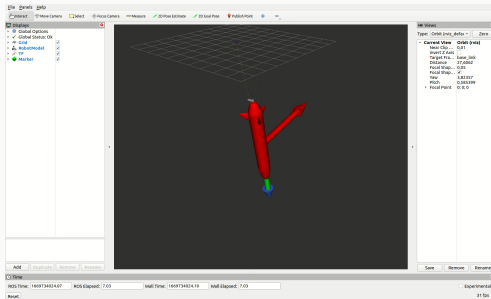


Figure 18: Flat navigation with  $w_a$  injection

## Simulation

- 1 constraint  $\mathbf{v} \perp \mathbf{u}$
- $\mathbf{u} = (0, 0, 1)^T_w$
- $\mathbf{v} = (1, 0, 0)^T$

## $w_a$ injection

- $w = (w_x, 0, 0)$

## Conclusion

---

## Classical control

- Unsuitable for navigation in constrained environment
- Need a complete knowledge of  $\mathbf{R}$
- Not responsive enough




## Orthogonal control

- Partial knowledge of  $\mathbf{R}$
- Quickest reorientation
- Let controllable degrees of freedom

**Questions?**

## References

---

-  Cid, J. Ángel and F. Adrián F. Tojo (2018). *A Lipschitz condition along a transversal foliation implies local uniqueness for ODEs.*
-  Fossen, T.I. (2011). *Handbook of Marine Craft Hydrodynamics and Motion Control.*
-  Jaulin, L. (2019). *Mobile Robotics.*